

Tulum chair

by Eugeni Quitllet

Tulum, designed by Eugeni Quitllet, is a collection of designer furniture to live freely anywhere in the world.



Info

Description

Eugeni Quitllet presents a chair that combines advanced technology and high quality materials. Made with epoxy-treated profiles and precise welding, it guarantees exceptional durability. The armrests feature Indonesian teak wood details,

adding a natural and elegant touch. The upholstered seat and backrest offer superior comfort. Tulum can be customised with a variety of fabrics, adapting to different styles and needs.

Weight: 12 Kg

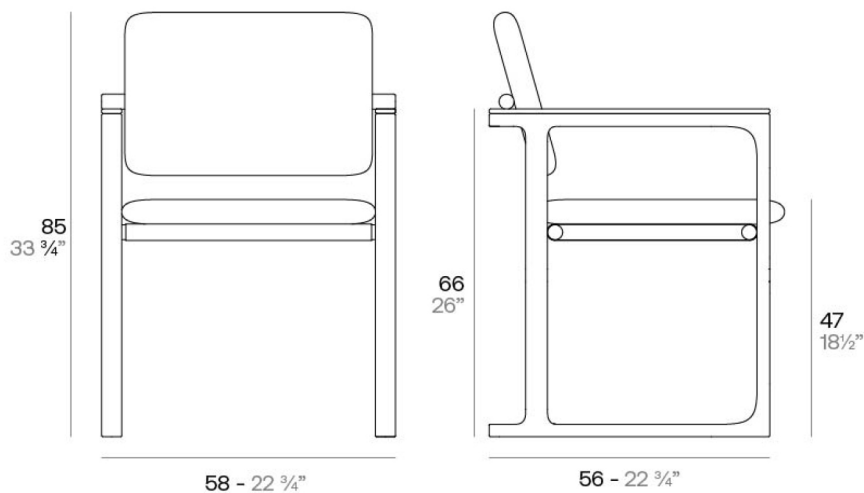

Tulum. Sillón
Tulum. Armchair
ref. 65079

Finishes

finishes

ALUMINIUM

Ref. 65079E



white



smoked

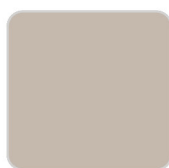

ecru



tortora

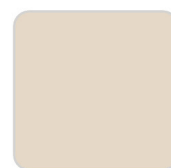

cream

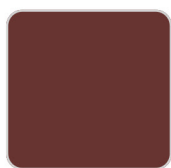

garnet

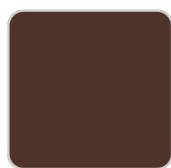

brown



green



blue



gray



anthracite



black

fabric

GETARIA

Ref. 65079CO



oasis 10007



black 10044



gallant 10025



anthracite 10043



blue 10024

VONDOM



pearl 10006



gray 10042



ocean 10023



aquamarine 10003



white 10041

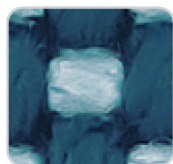

emerald 10016

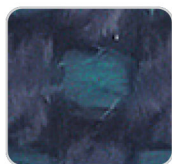

oversea 10002

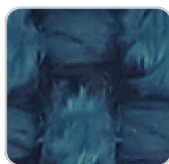

green 10053



moon 10040



niord 10015



brown 10050



terra 10039

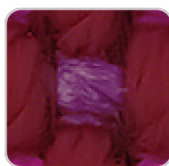

aphrodite 10013



tortora 10048



dune 10009



cream 10047



iceberg 10037

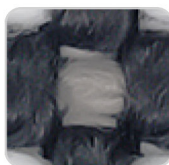

granite 10008

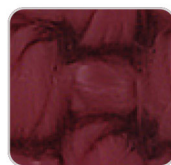

garnet 10046



camel 10033

Premium high density 100% acrylic fabric, available in a wide range of colors.

BAIONA

Ref. 65079CO

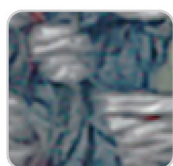

blue 10112

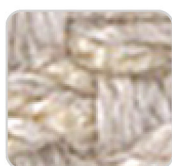

cream 10103

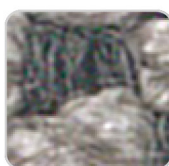

tortora 10102

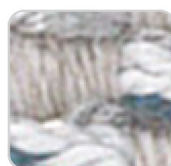

ocean 10111



ecru 10101

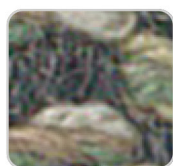

green 10110

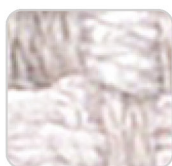

white 10100

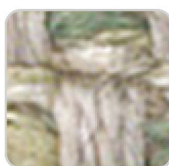

jade 10109

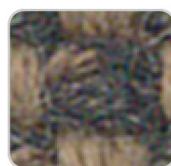

brown 10108

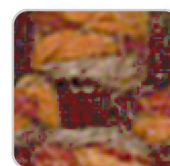

garnet 10107

VONDOM

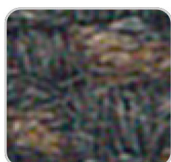

anthracite 10114

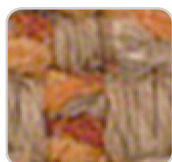

clay 10106



gray 10113



camel 10104

High density 100% acrylic fabric, which provides a solid feel. It has an irregular pattern that adds a handcrafted touch.

CALELLA Ref. 65079CO

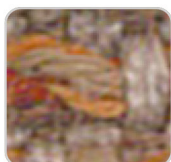

clay 10125

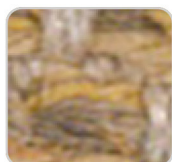

mustard 10124

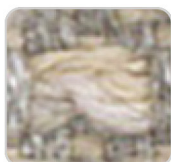

cream 10123

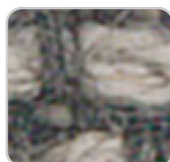

tortora 10122

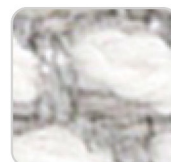

ecru 10121

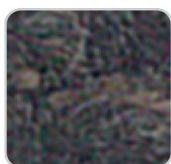

anthracite 10129

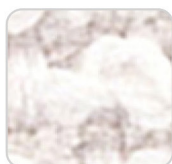

white 10120

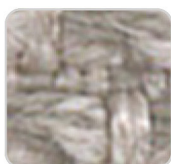

gray 10128

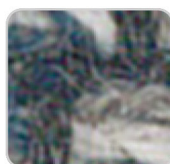

blue 10127

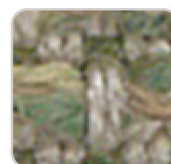

jade 10126

PFAS-free 100% acrylic fabric with a rich and unusual texture and an exceptional softness, which enhances the comfort of the furniture.

FISTERRA Ref. 65079CO



cream 10132



white 10130



ecru 10131

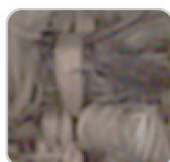

tortora 10135



camel 10134

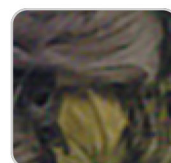
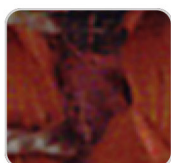

VONDOM

peach 10146



jade 10139

clay 10137



green 10140

garnet 10138



ocean 10141

brown 10136

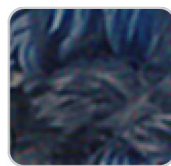

blue 10142

olive 10145



gray 10143



anthracite 10144



black 10147

100% acrylic fabric, with a distinctive irregular marbled pattern and a soft feel.

PORTONOVO

Ref. 65079CO

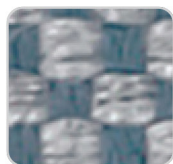

ocean 10161



cream 10153



green 10160



tortora 10152



jade 10159



ecru 10151

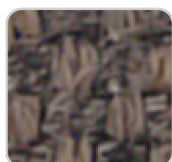

brown 10158

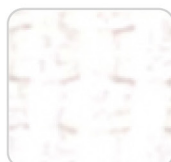

white 10150



black 10165

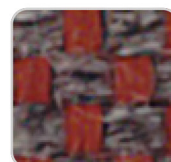

garnet 10157

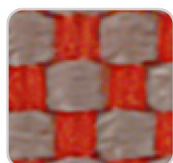

clay 10156



anthracite 10164

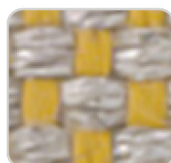

mustard 10155



gray 10163

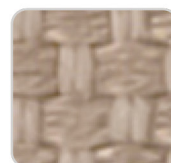

camel 10154

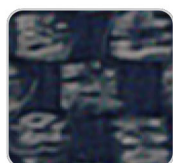

blue 10162

100% acrylic fabric, with a flat and simple design, which adapts to any decorative

VONDOM

style.

ZUMAIA

Ref. 65079CO

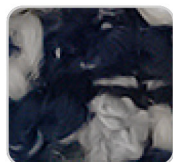

blue 10203



garnet 10202



cream 10201



white 10200



black 10205



green 10204

Elegant 100% acrylic fabric, with a soft terry, pleasant to the touch and a unique color combination.

SUANCES

Ref. 65079CO

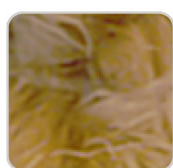

mustard 10305



gray 10313

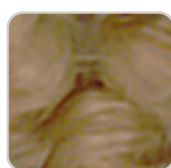

camel 10304

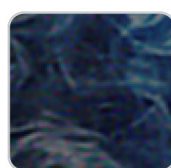

blue 10312

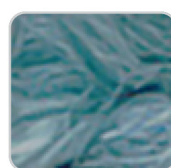

ocean 10311

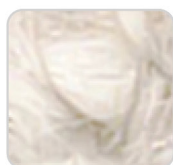

cream 10303



green 10310

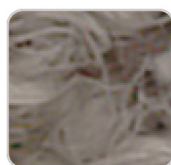

tortora 10302



olive 10317

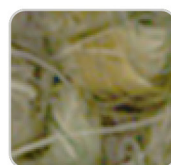

jade 10309



ecu 10301

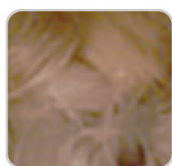

peach 10316



brown 10308



white 10300

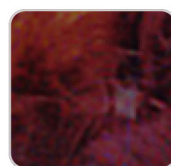

garnet 10307

VONDOM

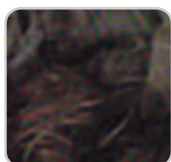

black 10315



clay 10306

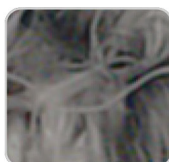

antrahacite 10314

Bocle fabric, which stands out for its warmth and softness, with matching colors that add depth and elegance.

RIBADEO

Ref. 65079CO



antrahacite 10334



clay 10326

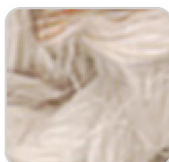

cream 10323



gray 10333



mustard 10325



tortora 10322



blue 10332



camel 10324



ecru 10321



white 10320

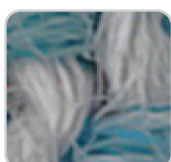

ocean 10331



green 10330



mint 10337



jade 10329

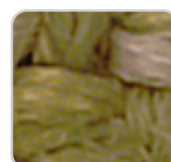

olive 10336

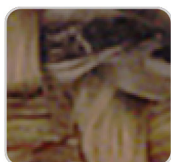

brown 10328



peach 10335

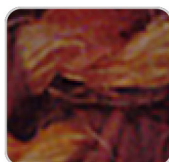

garnet 10327

Soft fabric with marbled yarns of different thicknesses that create a rich and visually interesting texture. Its Linen look adds a touch of natural style.

LOURO

Ref. 65079CO

VONDOM



peach 10355



clay 10346



antrahacite 10354



mustard 10345



gray 10353

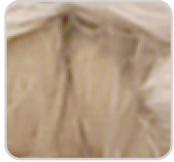

camel 10344



blue 10352



cream 10343



ocean 10351



tortora 10342



green 10350



jade 10349



brown 10348



olive 10356



garnet 10347

Soft and versatile fabric, which presents a neutral base color that makes it easy to combine with different colors and fabrics.

ALTEA

Ref. 65079CO



tortora 1102



white 1100

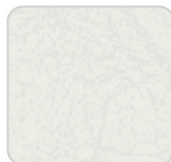

ecru 1111

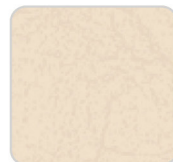

cream 1103

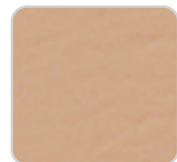

camel 1120



clay 1122

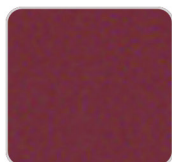

garnet 1106



brown 1104

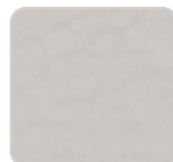

jade 1125



ocean 1123



blue 1114



gray 1101

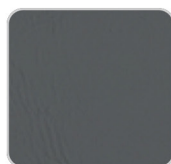

anthracite 1124



black 1105

Soft outdoor fabric with leather-like texture.

VONDOM

AROUSA
Ref. 65079CO



ecru 1221



white 1219



tortora 1209



cream 1220



camel 1230

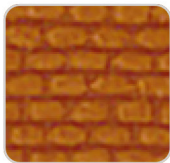

clay 1231

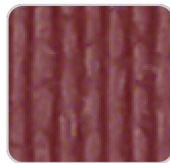

garnet 1223

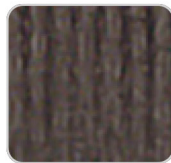

brown 1214

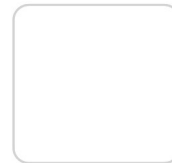

jade 1235

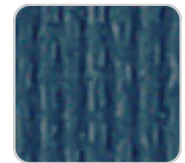

blue 1222



gray 1208



anthracite 1210

Soft outdoor fabric with shiny finish.

Ambients

