

**Description**  
**Beschreibung**

Modular upholstered 2 and 3-seater sofa with solid iroko wood base and different module options: linear or angular, seat and backrest, open seat and backrest, with upholstered arm or solid iroko wood table available in 2 heights. Valid for outdoor use.

Modulare Polstersofas in verschiedenen Ausführungen: Ecke, Chaiselongue und gebogen. Gestell und Armlehnen aus massivem Iroko-Holz. Ausführung mit gepolsterter Fußstütze. Mit Gelenksystem. Innenfutter in verschiedenen Farben. Für den Außenbereich geeignet.

**Upholstery**  
**Bezug**

Andreu World collections use various types of upholstery in acrylic and faux leather that are especially designed for outdoor use. The covers and cushions are made of waterproof polyester fabric to protect the furniture from moisture, rain, and sun. For fabrics in our catalogue not specified in this box or customers own materials please contact our Customer Service Department.

In den Andreu World Outdoor Kollektionen werden verschiedene Stoffe aus Acrylfasern und Kunstleder, die speziell für den Aussenbereich konzipiert sind angeboten. Die Kissen und Bezüge sind aus hochwertigem, wasserabweisendem, UV- und schimmelbeständigem Stoff gefertigt. Für den Einsatz anderer Stoffe, setzen Sie sich bitte mit unserer Verkaufsabteilung in Verbindung.

**Fabrics / Stoffe**

- 1 Sand  
Reel One
- 2 Solid & Stripes  
Tack One
- 3 Natte  
Loom Two  
Mezzo  
Reel two
- 4 Heritage  
Savane  
Reel Three  
Reel Four

- 6 Chartres  
Zori  
Patio  
Tack Two  
Tack Three

- 7 Tack Five

- 8 Domino  
Lopi

- 9 Tack Four

**Faux Leather / Kunstleder**

- 2 Silvertex
- 3 Maglia
- 10 Coast

**Wood finish Iroko**  
**Holzausführungen**  
**Iroko**

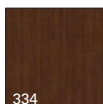

**Intellectual property Geistiges Eigentum**

All our collections are protected by international industrial design registries, designs patents, copyrights and intellectual Property laws. Unauthorized use of AW International Property is a criminal offence and can lead to prosecution.

Alle unsere Kollektionen sind durch internationale Industrie-Design Registern, Design Patente, Urheberrecht und gesitztes Eigentum rechtlich geschützt. Die unbefugte Nutzung des internationalen Eigentums von AW ist eine Straftat und kann zur Strafverfolgung führen.



**SF2388** NEW

Modular sofa with upholstered seat and backrest and solid iroko wood structure.  
 Modulsofa mit gepolsterter Sitzfläche und Rückenlehne, Rahmen aus massivem Iroko-Holz.

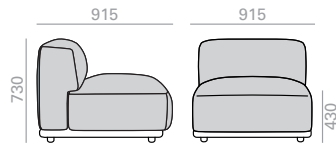

	COM cm. per unit
1 units	340
10 units or more	340

0'68 m3  
 35 kg  
 x1

**SF2389** NEW

Modular sofa with upholstered seat and backrest and structure and armrest (left side) in solid iroko wood.  
 Modulsofa mit gepolsterter Sitzfläche und Rückenlehne, Gestell und Armlehne (linke Seite) aus massivem Iroko-Holz.

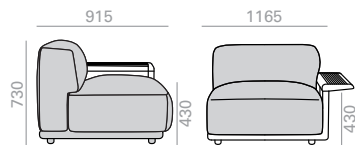

	COM cm. per unit
1 units	340
10 units or more	340

0'86 m3  
 40 kg  
 x1

**SF2390** NEW

Modular sofa with upholstered seat and backrest and structure and armrest (right side) in solid iroko wood.  
 Modulsofa mit gepolsterter Sitzfläche und Rückenlehne sowie Gestell und Armlehnen (rechte Seite) aus massivem Iroko-Holz.

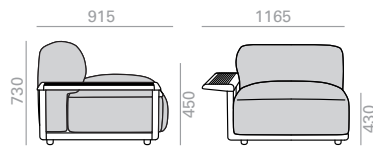

	COM cm. per unit
1 units	340
10 units or more	340

0'86 m3  
 40 kg  
 x1

**SF2391** NEW

Modular corner sofa (left side) with upholstered seat and backrest and solid iroko wood structure.  
 Modulare Ecksofa (linke Seite) mit gepolsterter Sitzfläche und Rückenlehne und Gestell aus massivem Iroko-Holz.

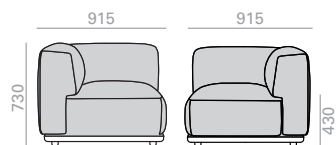

	COM cm. per unit
1 units	430
10 units or more	430

0'68 m3  
 40 kg  
 x1

**SF2392** NEW

Modular corner sofa (right side) with upholstered seat and backrest and solid iroko wood structure.  
 Modulares Ecksofa (rechte Seite) mit gepolsterter Sitzfläche und Rückenlehne und Gestell aus massivem Iroko-Holz.

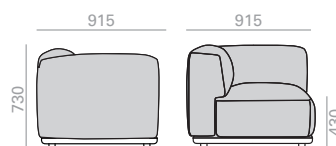

	COM cm. per unit
1 units	430
10 units or more	430

0'68 m3  
 40 kg  
 x1

SF2393 **NEW**

Modular chaise lounge sofa with upholstered seat and backrest and solid iroko wood structure.  
 Modulare Chaiselongue mit gepolsterter Sitzfläche und Rückenlehne und Gestell aus massivem Iroko-Holz.

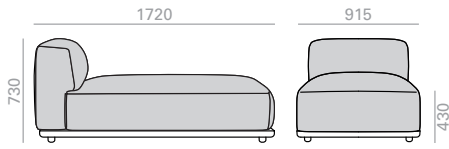

	COM cm. per unit
1 units	500
10 units or more	500

1'25 m<sup>3</sup>  
 50 kg  
 x1

RS2394 **NEW**

Upholstered footrest with solid iroko wood structure.  
 Gepolsterte FüÙe mit Struktur aus massivem Iroko-Holz.

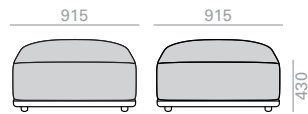

	COM cm. per unit
1 units	200
10 units or more	200

0'43 m<sup>3</sup>  
 28 kg  
 x1

ME2395 **NEW**

Solid iroko wood side table.  
 Beistelltisch aus massivem Iroko-Holz.

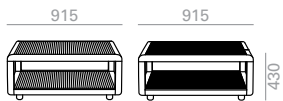

0'38 m<sup>3</sup>  
 32 kg  
 x1

**Examples of modular configurations**  
**Beispiele modularer Kombinationen**

**Set 1 / Satz 1**

2 Modules 2 Module  
 SF2390 + SF2389

	COM cm. per unit
1 units	680
10 units or more	680

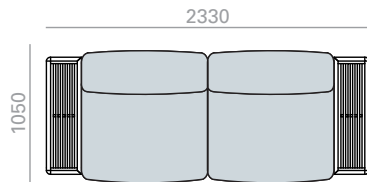

**Set 2 / Satz 2**

3 Modules 3 Module  
 SF2390 + SF2388 + SF2389

	COM cm. per unit
1 units	1020
10 units or more	1020

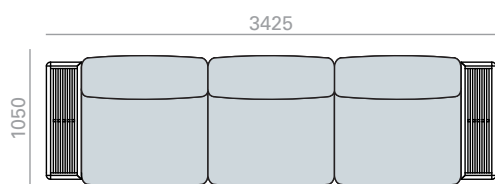

**Examples of modular configurations**  
**Beispiele modularer Kombinationen**

**Set 3 / Satz 3**

4 Modules 4 Module  
 SF2390 + SF2388 + SF2388 + SF2389

	COM cm. per unit
1 units	1360
10 units or more	1360

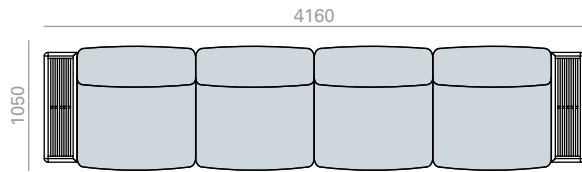

**Set 4 / Satz 4**

2 Modules 2 Module  
 SF2392 + SF2391

	COM cm. per unit
1 units	860
10 units or more	860

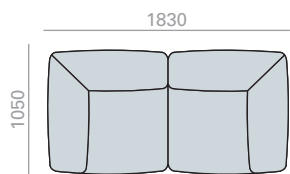

**Examples of modular configurations**  
**Beispiele modularer Kombinationen**

**Set 5 / Satz 5**

3 Modules 3 Module  
 SF2392 + SF2388 + SF2391

	COM cm. per unit
1 units	1200
10 units or more	1200

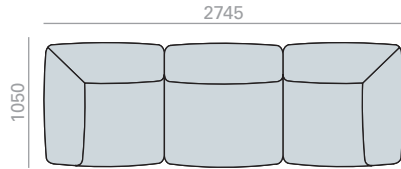

**Set 6 / Satz 6**

4 Modules 4 Module  
 SF2392 + SF2388 + SF2388 + SF2391

	COM cm. per unit
1 units	1540
10 units or more	1540

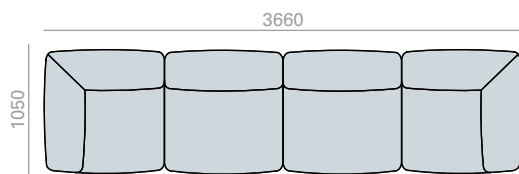

**Examples of modular configurations  
Beispiele modularer Kombinationen**

**Set 7 / Satz 7**

3 Modules 3 Module  
SF2390 + SF2388 + SF2392

	COM cm. per unit
1 units	1110
10 units or more	1110

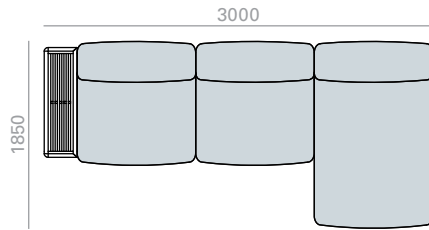

**Set 8 / Satz 8**

4 Modules 4 Module  
SF2390 + SF2388 + SF2388 + SF2393

	COM cm. per unit
1 units	1520
10 units or more	1520

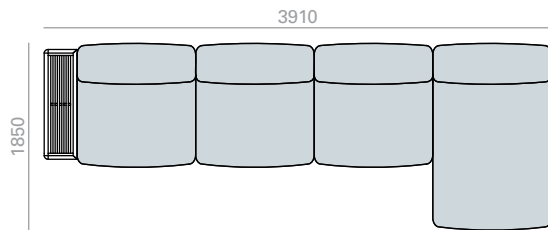

Examples of modular configurations  
Beispiele modularer Kombinationen

**Set 9 / Satz 9**

5 Modules 5 Module

SF2393 + SF2388 + SF2388 + SF2388 + SF2393

	COM cm. per unit
1 units	2020
10 units or more	2020

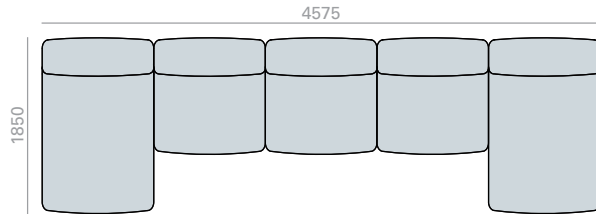

**Set 10 / Satz 10**

3 Modules 3 Module

SF2390 + SF2388 + SF2394

	COM cm. per unit
1 units	680
10 units or more	680

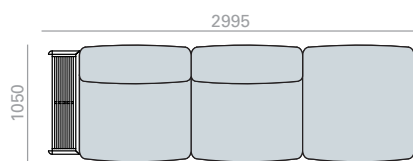



**Examples of modular configurations  
Beispiele modularer Kombinationen**

**Set 11 / Satz 11**

4 Modules 4 Module  
SF2390 + SF2388 + SF2394 + SF2389

	COM cm. per unit
1 units	1020
10 units or more	1020

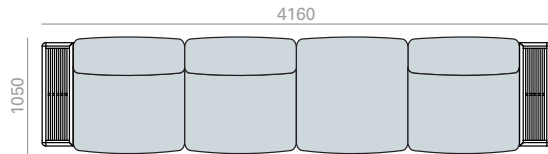

**Set 12 / Satz 12**

3 Modules 3 Module  
SF2392 + SF2388 + SF2394

	COM cm. per unit
1 units	770
10 units or more	770

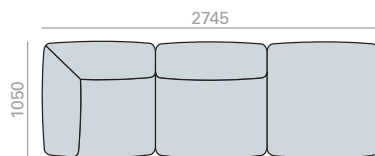

**Examples of modular configurations**  
**Beispiele modularer Kombinationen**

**Set 13 / Satz 13**

4 Modules 4 Module  
 SF2392 + SF2388 + SF2394 + SF2391

	COM cm. per unit
1 units	1200
10 units or more	1200

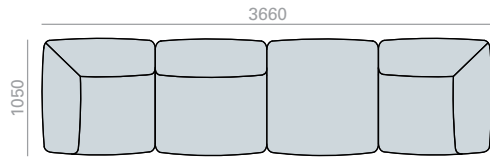

**Set 14 / Satz 14**

3 Modules 3 Module  
 SF2390 + SF2388 + ME2395

	COM cm. per unit
1 units	680
10 units or more	680

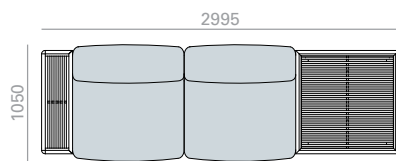

**Examples of modular configurations  
Beispiele modularer Kombinationen**

**Set 15 / Satz 15**

4 Modules 4 Module  
SF2390 + SF2388 + SF2391 + SF2389

	COM cm. per unit
1 units	1450
10 units or more	1450

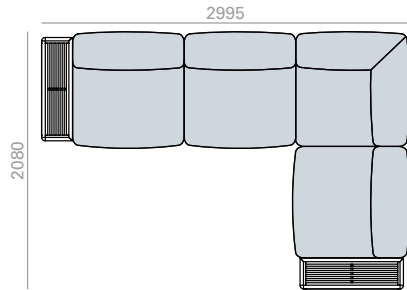

**Set 16 / Satz 16**

5 Modules 5 Module  
SF2390 + SF2388 + SF2391 + SF2388 + SF2389

	COM cm. per unit
1 units	1790
10 units or more	1790

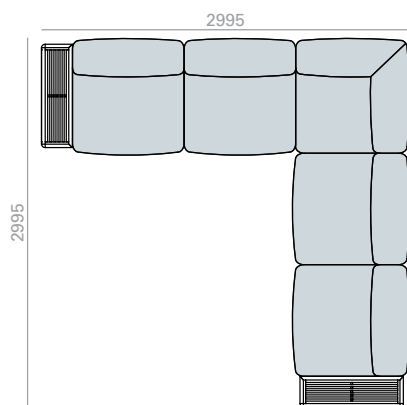

**Examples of modular configurations**  
**Beispiele modularer Kombinationen**

**Set 17 / Satz 17**

6 Modules 6 Module  
 SF2390 + SF2388 + SF2388 + SF2391 +  
 SF2388 + SF2389

	COM cm. per unit
1 units	2130
10 units or more	2130

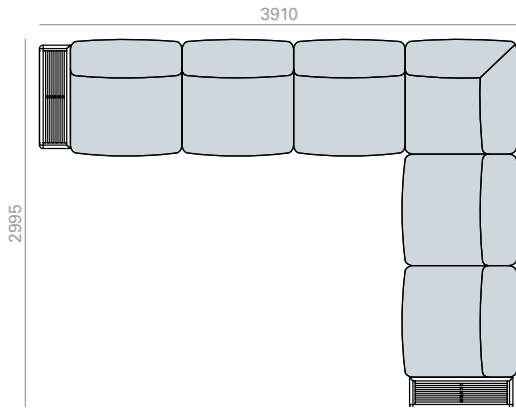

**Set 18 / Satz 18**

7 Modules 7 Module  
 SF2390 + SF2388 + SF2388 + SF2391 +  
 SF2388 + SF2388 + SF2389

	COM cm. per unit
1 units	2470
10 units or more	2470

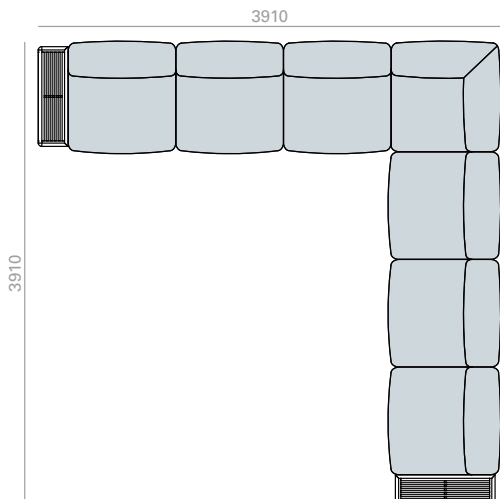

**Examples of modular configurations**  
**Beispiele modularer Kombinationen**

**Set 19 / Satz 19**

4 Modules 4 Module  
 SF2392 + SF2388 + SF2391 + SF2391

	COM cm. per unit
1 units	1630
10 units or more	1630

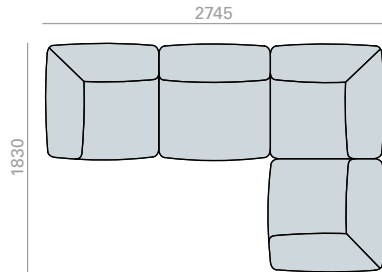

**Set 20 / Satz 20**

5 Modules 5 Module  
 SF2392 + SF2388 + SF2391 + SF2388 + SF2391

	COM cm. per unit
1 units	1970
10 units or more	1970

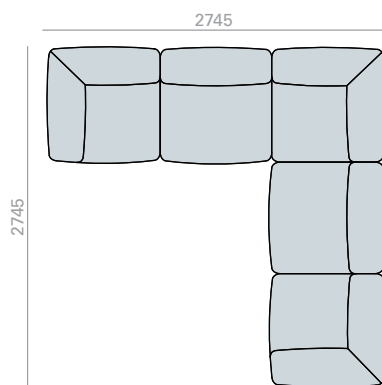

**Examples of modular configurations**  
**Beispiele modularer Kombinationen**

**Set 21 / Satz 21**

6 Modules 6 Module

SF2392 + SF2388 + SF2388 + SF2391 + SF2388  
 + SF2391

	COM cm. per unit
1 units	2310
10 units or more	2310

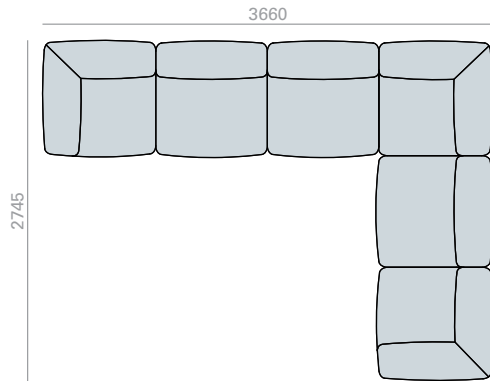

**Set 22 / Satz 22**

7 Modules 7 Module

SF2392 + SF2388 + SF2388 + SF2391 + SF2388 +  
 SF2388 + SF2391

	COM cm. per unit
1 units	2650
10 units or more	2650

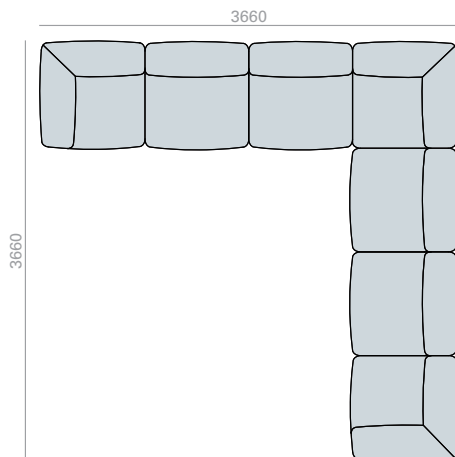

**Examples of modular configurations**  
**Beispiele modularer Kombinationen**

**Set 23 / Satz 23**

4 Modules 4 Module  
 SF2390 + SF2388 + SF2394 + SF2389

	COM cm. per unit
1 units	1020
10 units or more	1020

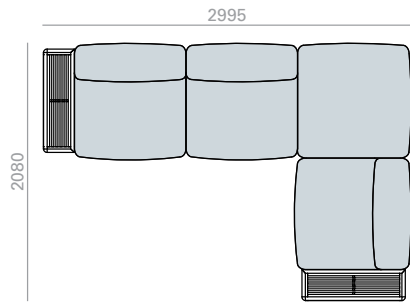

**Set 24 / Satz 24**

5 Modules 5 Module  
 SF2390 + SF2388 + SF2394 + SF2388 + SF2389

	COM cm. per unit
1 units	1360
10 units or more	1360

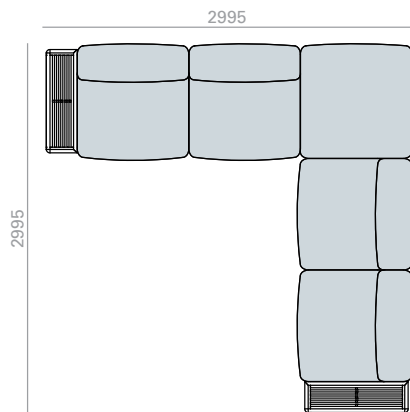

**Examples of modular configurations**  
**Beispiele modularer Kombinationen**

**Set 25 / Satz 25**

4 Modules 4 Module

SF2392 + SF2388 + SF2394 + SF2391

	COM cm. per unit
1 units	1200
10 units or more	1200

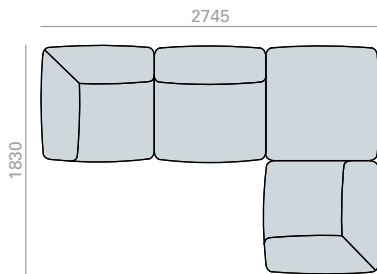

**Set 26 / Satz 26**

5 Modules 5 Module

SF2392 + SF2388 + SF2394 + SF2388 + SF2391

	COM cm. per unit
1 units	1540
10 units or more	1540

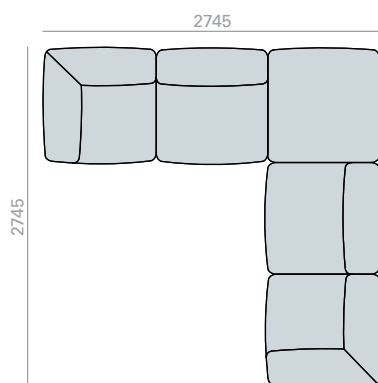



**Examples of modular configurations**  
**Beispiele modularer Kombinationen**

**Set 27 / Satz 27**

4 Modules 4 Module  
 SF2390 + SF2388 + ME2395 + SF2389

	COM cm. per unit
1 units	1020
10 units or more	1020

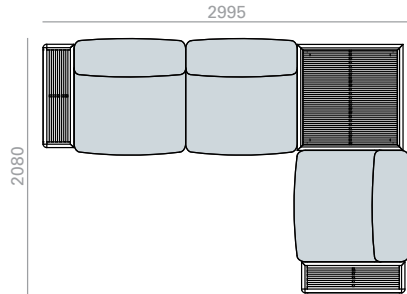

**Set 28 / Satz 28**

5 Modules 5 Module  
 SF2390 + SF2388 + ME2395 + SF2388 + SF2389

	COM cm. per unit
1 units	1360
10 units or more	1360

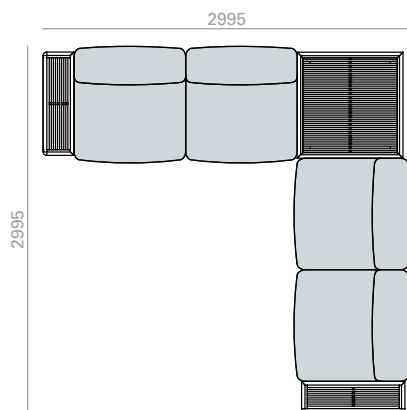

**Examples of modular configurations**  
**Beispiele modularer Kombinationen**

**Set 29 / Satz 29**

4 Modules 4 Module  
 SF2392 + SF2388 + ME2395 + SF2391

	COM cm. per unit
1 units	1200
10 units or more	1200

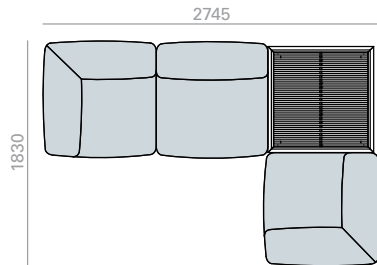

**Set 30 / Satz 30**

5 Modules 5 Module  
 SF2392 + SF2388 + ME2395 + SF2388 + SF2391

	COM cm. per unit
1 units	1540
10 units or more	1540

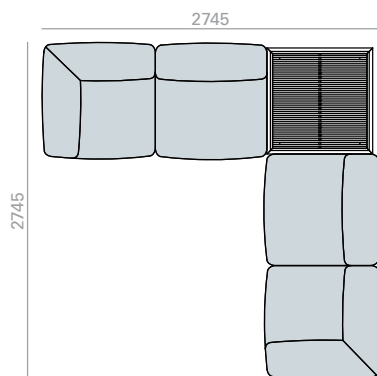

**Examples of modular configurations  
Beispiele modularer Kombinationen**

**Set 31 / Satz 31**

6 Modules 6 Module

SF2390 + SF2392 + SF2388 + SF2388 + SF2391 + SF2389

	COM cm. per unit
1 units	2220
10 units or more	2220

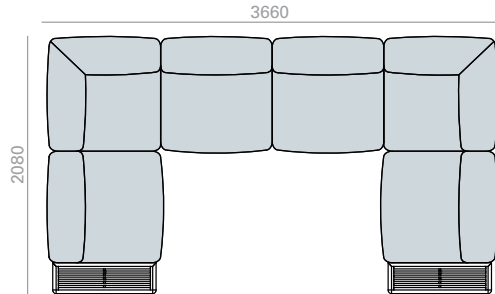

**Set 32 / Satz 32**

8 Modules 8 Module

SF2390 + SF2388 + SF2392 + SF2388 + SF2388 + SF2391 + SF2388 + SF2389

	COM cm. per unit
1 units	2900
10 units or more	2900

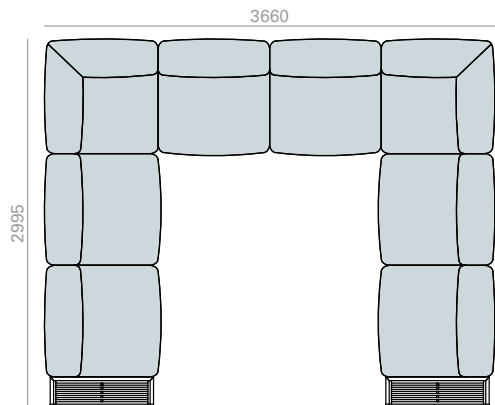

Examples of modular configurations  
Beispiele modularer Kombinationen

**Set 33 / Satz 33**

6 Modules 6 Module

SF2392 + SF2392 + SF2388 + SF2388 + SF2391  
+ SF2391

	COM cm. per unit
1 units	2400
10 units or more	2400

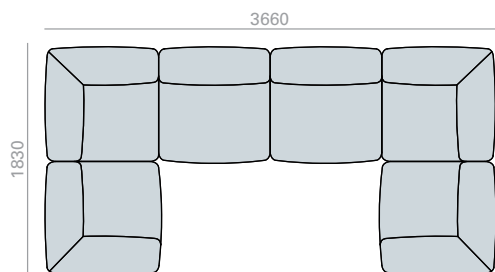

**Set 34 / Satz 34**

8 Modules 8 Module

SF2392 + SF2388 + SF2392 + SF2388 + SF2388 +  
SF2391 + SF2388 + SF2391

	COM cm. per unit
1 units	3080
10 units or more	3080

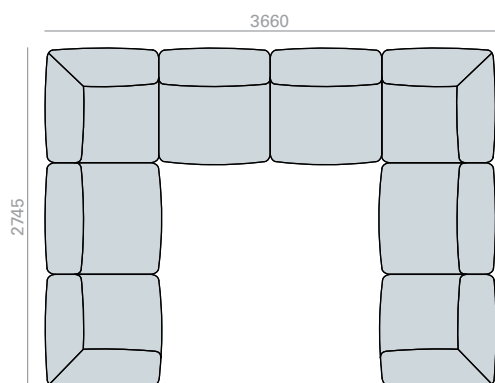

**Examples of modular configurations**  
**Beispiele modularer Kombinationen**

**Set 35 / Satz 35**

6 Modules 6 Module

SF2390 + SF2394 + SF2388 + SF2388 + SF2394  
 + SF2389

	COM cm. per unit
1 units	1360
10 units or more	1360

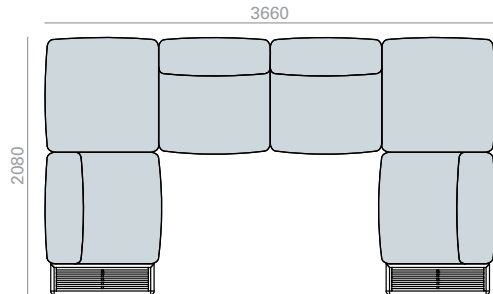

**Set 36 / Satz 36**

8 Modules 8 Module

SF2390 + SF2388 + SF2394 + SF2388 + SF2388 +  
 SF2394 + SF2388 + SF2389

	COM cm. per unit
1 units	2040
10 units or more	2040

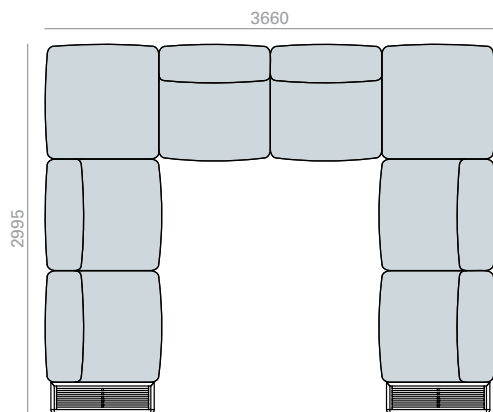

Examples of modular configurations  
Beispiele modularer Kombinationen

**Set 37 / Satz 37**

6 Modules 6 Module

SF2392 + SF2394 + SF2388 + SF2388 + SF2394 + SF2391

	COM cm. per unit
1 units	1540
10 units or more	1540

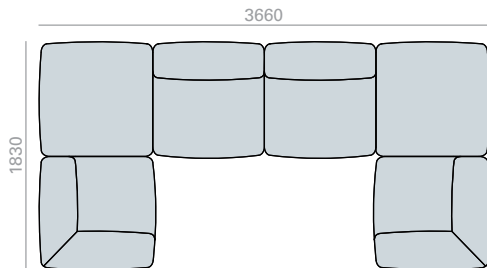

**Set 38 / Satz 38**

8 Modules 8 Module

SF2392 + SF2388 + SF2394 + SF2388 + SF2388 + SF2394 + SF2388 + SF2391

	COM cm. per unit
1 units	2220
10 units or more	2220

